

Dielenkammerverbau 400er Serie

Plattengreifer

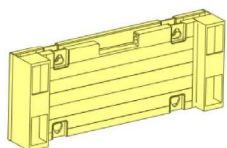

Dielenkammerplatte

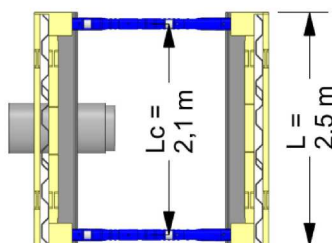
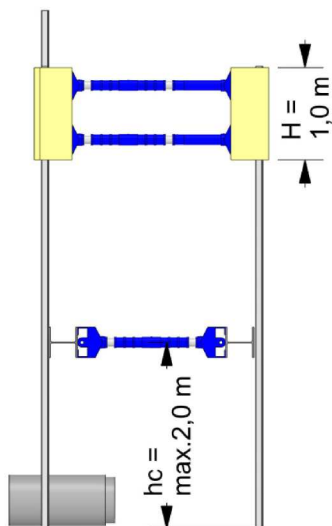
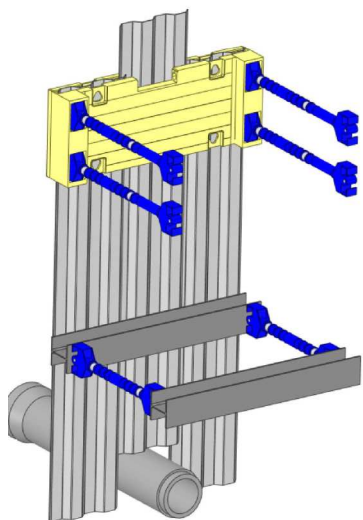
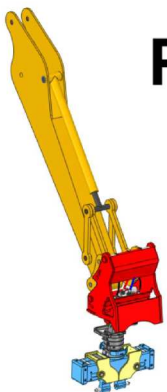
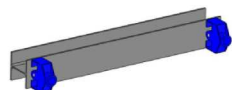

Gurtungsträger

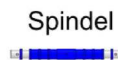

Zwischenrohr (intermediate pipe), shown as a blue line with a central dot.

Artikel Nr.	Element	L [m]	H [m]	Lc [m]	hc [m]
50 4003 154	Dielenkammerplatte	2,0	1,0	1,6	2,0
50 4003 155	Dielenkammerplatte	2,5	1,0	2,1	2,0
50 4002 151	Dielenkammerplatte	3,0	1,0	2,4	2,0
50 4003 152	Dielenkammerplatte	3,5	1,0	3,1	2,0
50 4001 151	Dielenkammerplatte	4,0	1,0	3,6	2,0
50 4003 153	Dielenkammerplatte	4,5	1,0	4,1	2,0
50 4003 131	Dielenkammerplatte	5,0	1,0	4,6	2,0

Artikel Nr.	Element	L [m]
99 4001 032	Gurtungsträger EGL	2,0
99 4001 042	Gurtungsträger EGL	2,5
99 4001 007	Gurtungsträger EGL	3,0
99 4001 005	Gurtungsträger DGL	3,0
99 4001 008	Gurtungsträger DGL	3,5
99 4001 003	Gurtungsträger DGL	4,0
99 4001 012	Gurtungsträger DGL	4,5
99 4001 011	Gurtungsträger DGL	5,0

Artikel Nr.	Element	L min. [m]	L max. [m]
99 0030 114	Spindel	1,0	1,3
99 0030 115	Spindel kurz	0,8	1,0

Artikel Nr.	Element	L [m]
99 0950 000	Zwischenrohr Set	0,3
99 0951 000	Zwischenrohr Set	0,5
99 0952 000	Zwischenrohr Set	0,8
99 0953 000	Zwischenrohr Set	1,0
99 0954 000	Zwischenrohr Set	1,5